



# SD SERIES

## MACHINE STANDS



SD Series  
02/21/19  
Item # 13025

Item #: \_\_\_\_\_  
 Project: \_\_\_\_\_  
 Qty: \_\_\_\_\_  
 AIA#: \_\_\_\_\_



**SD-200 Stand**  
Shown with a  
DM-200B



**SD-270 Stand**  
Shown with a  
DCM-270BAH-OS



**SD-500 Stand**  
Shown with a  
DCM-500BAH-OS



**SD-750 Stand**  
Shown with a  
DCM-751BAH-OS

### Features

- ▶ Heavy duty stands for floor model icemakers/dispensers
- ▶ Corrosion resistant stainless steel exterior
- ▶ Easy cleaning with attractive appearance

- Locking doors standard



#### Warranty:

5 Year Parts & Labor.  
Valid in United States, Canada, Puerto Rico and U.S. Territories. Contact factory for warranty in other countries.

Model Number	Use with Cubelet Ice maker/Dispenser	Exterior Dimensions W* x D* x H (height including legs)	Shipping Weight
SD-200	DM-200B	30 x 32 x 32 <sup>13/16</sup>	125 lbs.
SD-270	DCM-270BAH, DCM270BAH-OS	16 <sup>1/2</sup> x 24 x 35 <sup>3/16</sup>	95 lbs.
SD-500	DCM-300BAH, DCM-300BAH-OS, DCM-500B_H, DCM-500B_H-OS	25 <sup>7/8</sup> x 22 x 32 <sup>3/4</sup>	100 lbs.
SD-750	DCM-751B_H, DCM-751B_H-OS	34 x 28 x 32 <sup>3/4</sup>	125 lbs.

\*Width and depth measurements are for stands and do not include the flanged legs. Add approximately 1".

Hoshizaki reserves the right to change specifications without notice.



# SD SERIES

## MACHINE STANDS



SD Series  
02/21/19  
Item # 13025

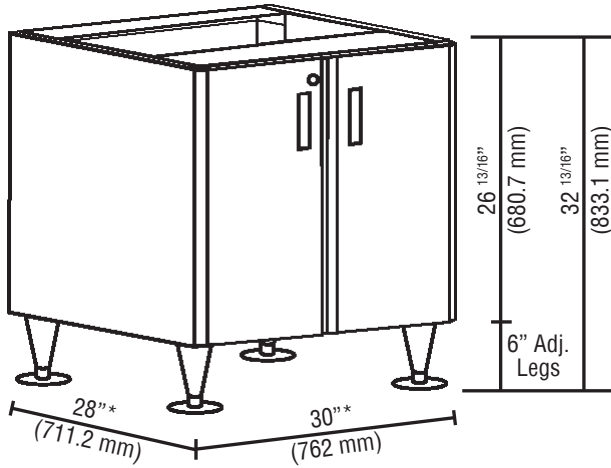

**SD-200**

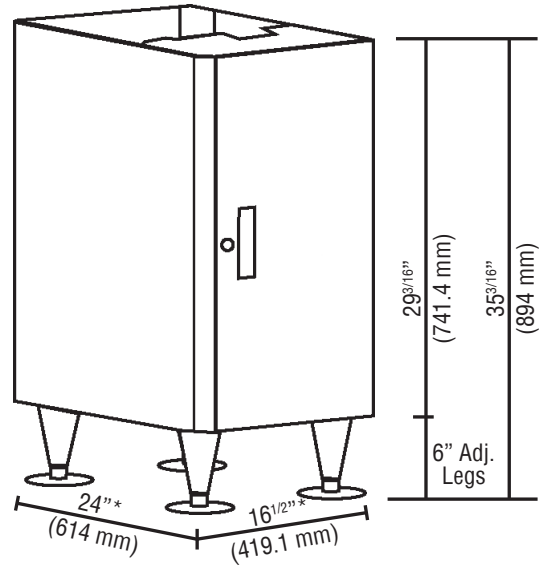

**SD-270**

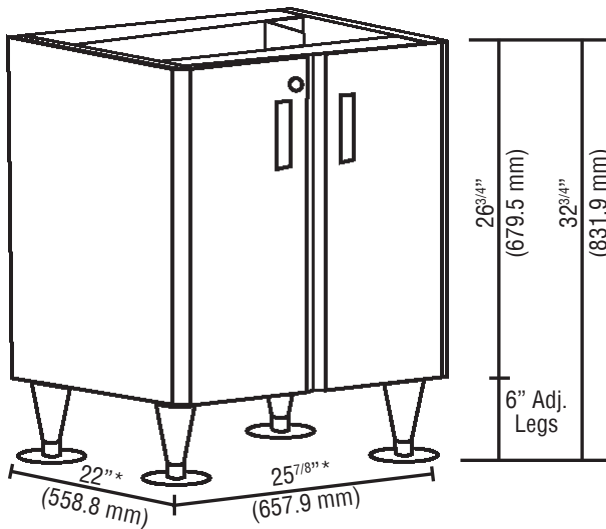

**SD-500**

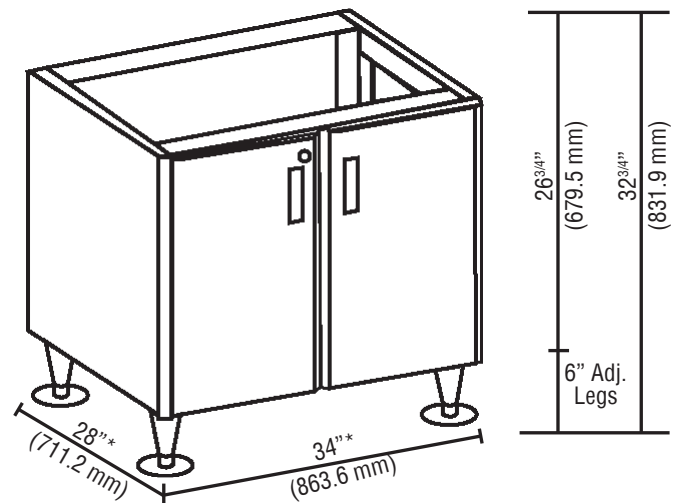

**SD-750**

\*Width and depth measurements are for stands and do not include the flanged legs. Add approximately 1".