



DCM-500B_H

SANITARY CUBELET ICE MACHINE/DISPENSER



DCM-500B_H
06/02/20
Item # 13226

Item #: _____
Project: _____
Qty: _____
AIA#: _____

Features

- ▶ Durable stainless steel exterior
- ▶ Advanced CleanCycle24™ design 
- ▶ Stainless steel auger with greaseless bearing

- Up to 618 lbs. of ice production per 24 hours
- Built-in storage capacity of 1.3ft³/40 lbs.*
- 2 second flush cycle every hour
- Corrosion resistant stainless steel exterior
- Easy to chew, cubelet ice
- Self-contained design reduces opportunities for cross contamination
- Protected by H-GUARD Plus Antimicrobial Agent 
- Dispenses ice and water
- R-404A Refrigerant

Warranty:

3 Year Parts & Labor on entire machine.
5 Year Parts on Compressor, air-cooled condenser coil.
Valid in United States, Canada, Puerto Rico and U.S. Territories. Contact factory for warranty in other countries.

*Rated in accordance with AHRI Standard 820(I-P). Capacity based on 100% of total volume x 30 lb/ft³ average density of ice.

Shipping: (LxWxH) 33" x 25.25" X 46" Volume: 22.18ft³

W x D x H
26" x 22¹/₂" x 40"
SD-500
25⁹/₁₀" x 22" x 32³/₄"



DCM-500BAH
Air-Cooled
Shown with optional
SD-500 Stand

DCM-500BWH
Water-Cooled



ICE PRODUCTION WATER USAGE ELECTRICAL

Condenser	Model	Air / Water Temp Lbs. per 24 hours		Potable Gal. per 100 lbs.	Condenser Gal. per 100 lbs.	kWh Used per 100 lbs.	Max. Fuse Size or HACR Circuit Breaker	Amperage	Voltage	Circuit Wires (including ground)	Heat Rejection BTU/hr.	Refrigerant Charge Amount	Net / Ship Weight (lbs.)
		70°/50°F	90°/70°F	90°/70°F	90°/70°F	90°/70°F							
Air-Cooled	DCM-500BAH	618	450	12.0	N/A	5.62	20A	12.9A	115V/60/1	3	7,000	1 lb. 4.1 oz.	251 / 255
Water-Cooled	DCM-500BWH	590	512	12.0	112	4.48	20A	12.6A	115V/60/1	3	6,000	11.5 oz.	245 / 255

Cubelet Dimensions*

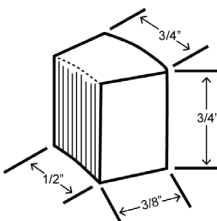

* approximate size in inches, image not to scale

Operating Limits

- Ambient Temp Range 45 - 100°F
- Water Temp Range 45 - 90°F
- Water Pressure 10 - 113 PSIG
- Voltage Range 104 - 127V

Service

- Allow 6" (15 cm) clearance at rear and sides for proper air circulation and ease of maintenance/service should they be required. Allow 24" (61 cm) clearance at top to allow for removal of the auger.

Plumbing

- Icemaker Water Supply Line: Min. 1/4" Nominal ID Copper Water Tubing or Equivalent
- Icemaker Drain Line: Min. 3/4" Nominal ID Hard Pipe or Equivalent Water-Cooled Model (Lines Must Be Independent of Icemaker)
- Condenser Water Supply Line: Min. 1/4" Nominal ID Copper Water Tubing or Equivalent
- Condenser Drain/Return Line: Min. 1/4" Nominal ID Hard Pipe (open drain system) or Copper Water Tubing (closed loop system) or Equivalent

Water Filter

Please refer to water filter specification sheet for recommendations.

Hoshizaki reserves the right to change specifications without notice.



DCM-500B_H

SANITARY CUBELET ICE MACHINE/DISPENSER



DCM-500B_H
06/02/20
Item # 13226

FRONT VIEW

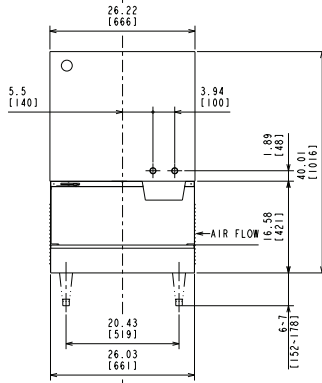

AIR-COOLED

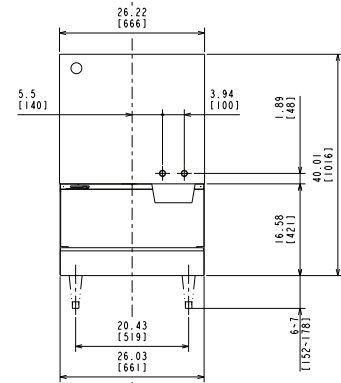

WATER-COOLED

inch
[mm]

SIDE VIEW

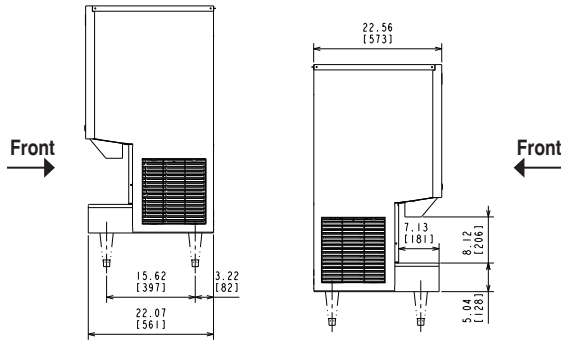

AIR-COOLED

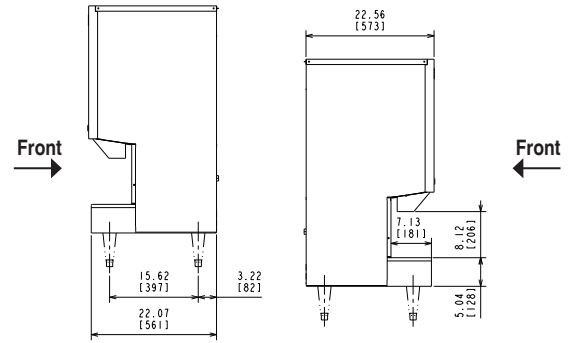

WATER-COOLED

REAR VIEW

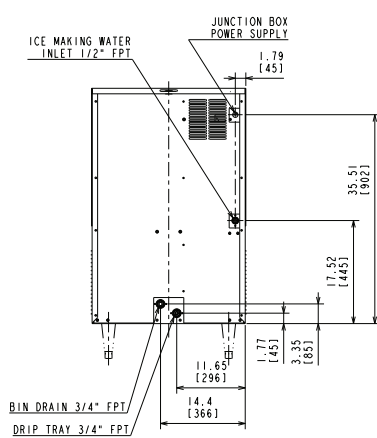

AIR-COOLED

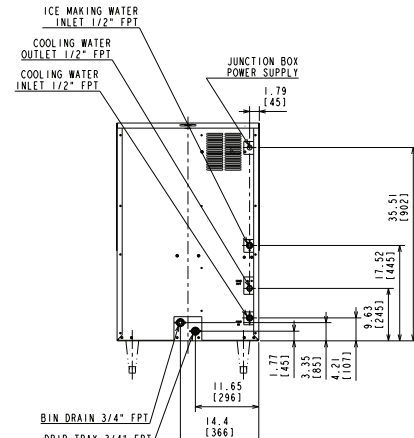

WATER-COOLED

TOP VIEW

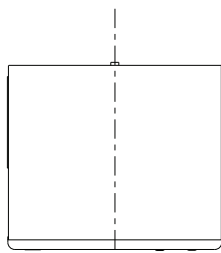

Front ↑
AIR-COOLED

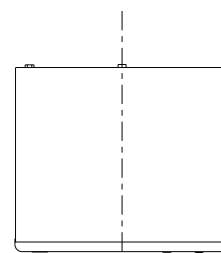

Front ↑
WATER-COOLED